

## Stress Strain Parameters of Geosynthetics to Consider in Construction Works

R. Diederich. DuPont de Nemours, Luxembourg. [romain.diederich@lux.dupont.com](mailto:romain.diederich@lux.dupont.com)

### ABSTRACT

The selection of geosynthetics for a given application is usually based on different index tests. Tensile Strength and Tensile Elongation is most often used to define a minimum performance for the required function and application. The research from independent institutes and DuPont de Nemours however demonstrate that the complete stress-strain results of geosynthetics have to be analysed in order to understand the performance in different construction works. The studies show a correlation between the resistance of a geotextile to the installation stresses and its energy absorption potential. A clear correspondence was also found between the initial tension stiffness of a geotextile and the deformation under loading.

### 1. INTRODUCTION

#### 1.1 Stress-Strain Properties

One of the most often used properties to characterise the performance of a geosynthetic is the wide-width tensile test. For geosynthetics, the ASTM D4595 or EN ISO 10319 standards have been developed. Though there are some minor differences the main principles are the same and both tests give similar results. The test is applicable to most geosynthetics, including woven, nonwoven or knitted geotextiles, felts but also geogrids and other open-structured geotextiles.

Typically the maximum load per unit width and the strain at maximum load is measured and used in specifications. Other measurements like secant stiffness, strain rate, energy absorption or singular points on the load-extension curve are also possible.

For geotextiles the energy absorption is defined as the area under the stress-strain curve. (fig.1)

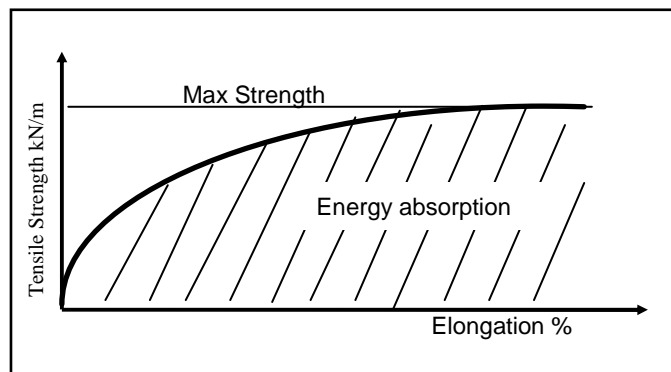

Figure 1. Energy absorption potential  $W$  of a geotextile

#### 1.2 Specification and Classification Systems

Since many years, geotextiles are used in various applications for separation, filtration, reinforcement and protection. To perform any of these functions, it is essential that the geotextile survives the construction induced stresses without being damaged. Several studies and analyses show that the critical period in the life of a geotextile is during the installation and construction phase rather than during the service life.

To ensure installation damage resistance, different specifications are being used. While in the early days the products were often specified by weight per unit area or by "brand name xxx or equivalent", with time and experience many countries developed more appropriate testing methods, national specifications and classification systems.

Despite the similarity of geological structures, available materials and construction techniques, the various national specification systems differ quite significantly. Properties such as tensile strength, puncture resistance and unit weight have long been recognised as the key parameters. Some systems consider also the importance of both strength and elongation properties. For example, the German classification system differentiates between woven (low elongation) and nonwoven geotextiles. The AASHTO M288 classification requires higher mechanical properties for geotextiles of lower elongation and sets the limit empirically at a 50% elongation level. The European standard EN 13249 "Required characteristics for geotextiles and geotextile-related products used in the construction of roads and other trafficked areas", requires for the separation function following mechanical characteristics: Tensile strength, elongation at maximum load, static puncturing (CBR) and dynamic perforation.

Certain national European classification systems are now incorporating the "elongation factor" into the combination of key properties and express the performance requirements in terms of the energy absorbing capabilities of the geotextile.

This energy absorption is the maximum energy a Geotextile can absorb before failure and is given as the integral of the stress-strain curve to the chosen point and expressed in kJ/m<sup>2</sup>. In some specifications however reference is made to an index (i.e. energy absorption index), which uses a simplified theoretical approach and define the energy absorption as the product of tensile strength ( $T$ ) and elongation ( $E$ ) at maximum strength)

$$W_{\text{index}} = \frac{1}{2} T_{\text{max}} \times E_{\text{max}}$$

SINTEF (Watn and Eiksund 1997) performed a research project on the mechanical damage of geotextiles during installation including field tests on frozen ground with a number of nonwoven geotextiles and concluded that the energy absorption of geotextiles is an important factor in the determination of damage resistance. After these tests a common specification "NorGeoSpec 2002" was introduced for Norway, Sweden and Finland.

## 2. DAMAGE DURING INSTALLATION TESTS

### 2.1 Product selection and properties

A range of commonly used geotextiles for separation applications was selected to be tested for the evaluation of the field performance. They differed in manufacturing process technologies, weights and mechanical properties. The following products were selected.

5 woven tape products

2 nonwoven products: needlepunched, continuous fiber

2 nonwoven products: thermally bonded, continuous fiber (PP/PET), low elongation (manufacturer A)

5 nonwoven products: thermally bonded, continuous fiber (PP), high elongation (manufacturer B)

To allow an evaluation of the most commonly required properties, the corresponding standard index tests were performed on each geotextile before the testing (table 1a and 1b). The correlation with these index tests and the damage during installation has been verified.

### 2.2 Test set-up

As the basis for the test, steel plates (2 x 2.5 m) were used. Steel chains were welded on two corners for the extraction. On top of the plates a soft clay subgrade from the local site was placed and compacted to a thickness of 25 cm. A geotextile sample (2 x 2 m) was laid directly on the subgrade and covered with a 25 cm thick layer of high furnace slag (40-60 cm diameter), which was dropped from a height of 50 cm on the geotextile. Then the system was compacted with a 7-ton vibratory roller (4 passes, forward and backward).

To extract the geotextile, the steel plate with the soil/geotextile/aggregate system on top was tilted and then lifted. The aggregate slid off the geotextile, so avoiding additional damage to the geotextile. All geotextiles were installed and extracted under identical conditions.

### 2.3 Evaluation of test results

After cleaning the samples, the edges (25 cm) were removed, and the remaining surface area (1.50 x 1.50 m) was analysed in the laboratory. The number and diameter of the holes was measured and used to determine the total damaged surface area (%) of each sample.

A 1.5 x 1.5 m template with a pre-determined pattern was placed on each sample in order to cut 10 specimen in both machine and cross direction. Using this pattern ensured that the same area of each geotextile sample was used to evaluate the remaining tensile strength after extraction

Table 1a. Selected products and measured properties (before testing)

Property	Standard	Unit	Woven Tape Geotextiles					
			86	146	87	177	109	
Area Weight	EN 965	g/m <sup>2</sup>	86	146	87	177	109	
Thickness	EN 964-1	µm	432	685	447	923	480	
Tensile Strength MD	EN 10319	kN/m	18	30	12	26	23	
Tensile Strength XD	EN 10319	kN/m	12	26	11	27	17	
Elongation MD	EN 10319	%	23	32	14	43	24	
Elongation XD	EN 10319	%	20	22	9	31	16	
Energy Abs. MD	EN 10319	kJ/m <sup>2</sup>	2.5	5.9	1.0	6.8	3.2	
Energy Abs. XD	EN 10319	kJ/m <sup>2</sup>	1.2	3.4	0.6	5.6	1.7	
CBR	EN 12236	kN	1.12	3.02	0.73	2.26	1.91	
Cone Penetration	EN 918	mm	16	12	27	11	16	
Grab MD	ASTM D4632	N	634	1055	511	1012	757	
Grab XD	ASTM D4632	N	378	709	411	864	488	
Trap Tear MD	ASTM D4533	N	281	388	241	484	252	
Trap Tear XD	ASTM D4533	N	201	365	203	672	254	

Table 1b. Selected products and measured properties (before testing)

Property	Needlepunched		Th.B. "A" PP/PE		Th.B. "B" PP				
	cont.	fiber							
Area Weight	114	155	113	133	91	111	127	137	168
Thickness	937	1254	737	753	393	389	416	442	485
Tensile Strength MD	8	13	6	8	4	8	8	8	11
Tensile Strength XD	8	13	6	11	6	7	9	9	13
Elongation MD	85	105	19	23	31	53	44	41	53
Elongation XD	74	48	18	24	50	53	52	47	54
Energy Abs. MD	3.7	7.8	0.8	1.4	1.1	3.4	2.8	2.7	4.8
Energy Abs. XD	3.2	3.8	0.7	1.7	2.2	2.9	3.5	3.2	5.3
CBR	1.35	1.87	1.00	1.64	0.72	1.23	1.26	1.30	1.75
Cone Penetration	29	29	43	36	48	33	30	26	24
Grab MD	522	719	422	726	381	644	677	707	997
Grab XD	504	646	393	596	428	608	662	717	1035
Trap Tear MD	263	406	224	335	188	330	310	390	459
Trap Tear XD	267	312	220	362	235	266	292	370	366

Table 2. Evaluation of damaged area and retained strength

	Woven Tape Geotextiles				Needlepunched cont.fibers			
Damaged area								
Holes total surface m <sup>2</sup>	0.157	0.020	0.126	0.002	0.082	0.007	0.004	
Sample surface m <sup>2</sup>	2.25	2.25	2.25	2.25	2.25	2.25	2.25	
% damaged surface	6.97	0.88	5.59	0.07	3.65	0.31	0.17	
% Retained Strength								
MD	43	62	56	100	77	80	79	
XD	95	85	79	94	70	85	78	
Avg.	62	73	67	97	74	82	78	

	Th.B. "A" PP/PE		Th.B. "B" PP					
Damaged area								
Holes total surface m <sup>2</sup>	0.096	0.200		0.072	0.011	0.016	0.005	0.006
Sample surface m <sup>2</sup>	2.25	2.25		2.25	2.25	2.25	2.25	2.25
% damaged surface	4.29	8.89		3.20	0.47	0.71	0.23	0.28
% Retained Strength								
MD	50	60		75	68	72	74	76
XD	48	39		60	93	74	90	87
Avg.	49	48		67	80	73	82	82

#### 2.4 Discussion of results

The correlation of the total damaged surface area (%) with all of the index tests was compared. A good correlation has been observed between the damaged surface area and retained strength (Fig. 2).

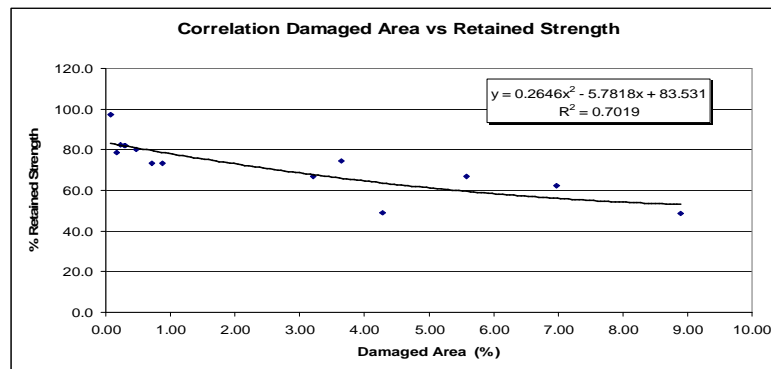

Figure 2. Correlation between damaged area and retained strength

Unit weight (Fig. 3) and thickness (Fig. 4) are descriptive properties and do not provide any information relating to performance when comparing different products. Only for products of the same "family" (i.e. manufactured according to the same process), the damage resistance is directly related to the uniform spread of its unit weight. At a uniform external stress, it is the weakest parts of the geotextile, which are the first to be damaged, therefore a uniform unit weight or thickness over the width of the product can be an indicator for the quality of a product.

For specification purposes, average unit weight and thickness are however irrelevant, since the unit weight to achieve a given performance depends on the different manufacturing technique.

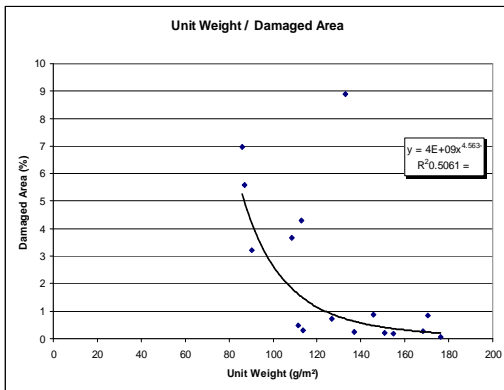

Figure 3. Damaged area versus unit weight

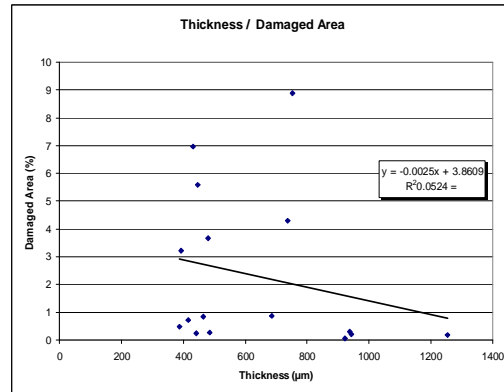

Figure 4. Damaged area versus thickness

No correlation was identified between the damage and any of the mechanical properties such as tensile strength, CBR puncture resistance, grab tensile strength and tear resistance (Fig. 5-8).

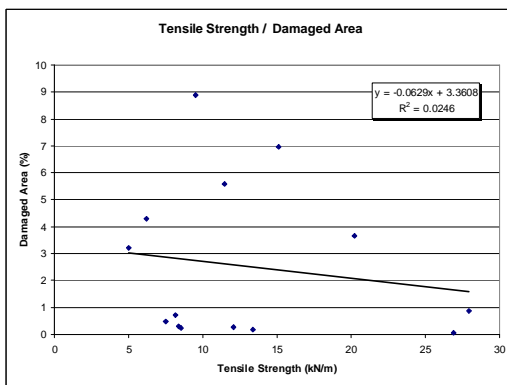

Figure 5. Damaged area versus tensile strength

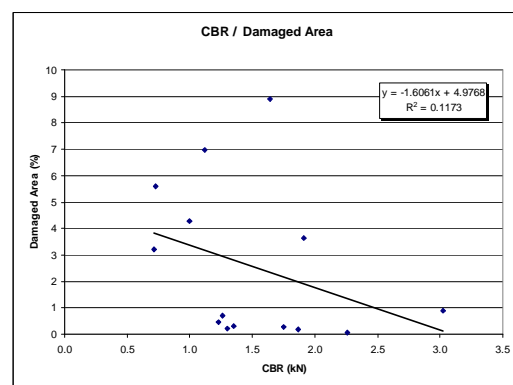

Figure 6. Damaged area versus CBR

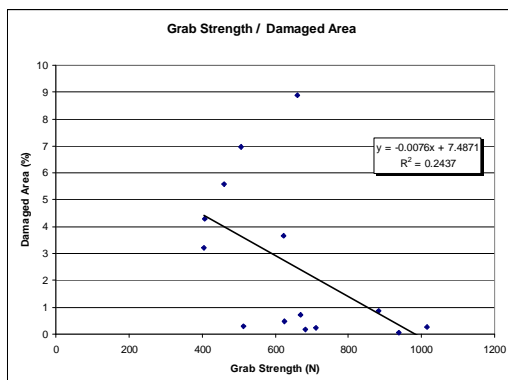

Figure 7. Damaged area versus grab strength

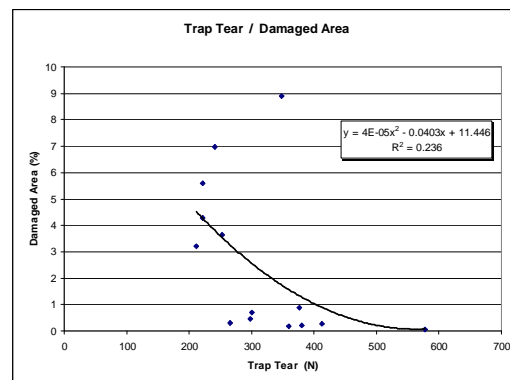

Figure 8. Damaged area versus Tear Strength

Although dynamic puncturing (Cone Penetration, Fig. 10) is usually regarded as a performance test simulating real conditions rather than an index test, no correlation has been observed during this test.

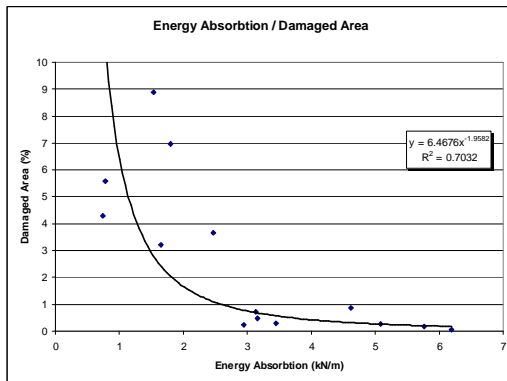

Figure 9. Damaged area versus energy absorption

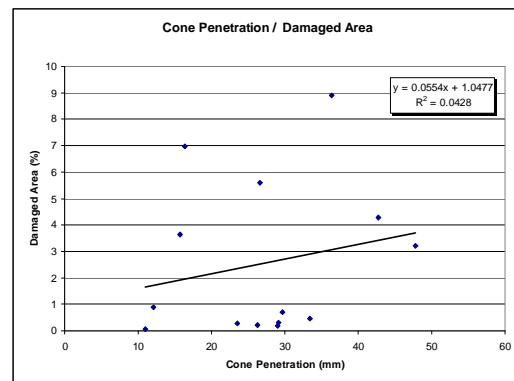

Figure 10. Damaged area versus Cone Drop

Excellent correlation has been found between the damaged area and the energy absorption (defined as the area under the stress-strain curve determined according to EN ISO 10319, Fig. 9). Under the used test conditions it is clearly seen that all geotextiles with an energy absorption of less than 3 kJ/m<sup>2</sup> have shown significant damage, whereas those geotextiles with an energy absorption greater than 3 kJ/m<sup>2</sup> survived these conditions without major damage.

## 2.5 Conclusions

The project provided useful information for evaluating the relevant properties and requirements for geotextiles to avoid damage during installation. The results showed that most properties used in several specification and classification systems do not reflect the behaviour in the field and supports the approach taken by different countries to include the energy absorption into their classification systems. A clear correlation between energy absorption and damage resistance has been found for all geotextiles tested, independent of their manufacturing process and physical structure. A common criteria based on the energy absorption principle allows the specifier to select the appropriate product performance depending on the different applications and site conditions. The test method developed allows a rapid and precise damage evaluation of geosynthetics and may be used as a basis for further determining performance related criteria.

## 3. DEFORMATION UNDER CYCLIC LOADS

SINTEF Civil and Environmental Engineering have performed a research project on different nonwoven geotextiles in road constructions. Index tests and large scale laboratory load tests have been performed to study the effect of stress-strain properties on nonwoven geotextiles on road deformations at cyclic loading.

### 3.1 Product selection and properties

Nonwoven products classified according to the Norwegian classification system have been tested. The products were manufactured at different process conditions. For each group short fibre needlepunched, continuous fibre needlepunched and thermally bonded products have been used (table 3).

Table 3: Selected products and measured properties

Application class in Norway	Reference	Type of product	Nominal weight (g/m <sup>2</sup> )
3	GTX 1	Staple fibre, needle punched	190
3	GTX 2	Continuous filament, needle punched	160
3	GTX 3	Continuous filament, thermally bonded	190
4	GTX 4	Staple fibre, needle punched	320
4	GTX 5	Continuous filament, needle punched	320
Not classified	GTX 6	Continuous filament, thermally bonded	290

Reference	Nominal Weight (g/m <sup>2</sup> )	CBR EN ISO 12236 N	Tensile Strength EN ISO 10319 kN/m	Cone Drop EN 918 mm	Strength at 5% EN ISO 10319 kN/m
GTX 1	190	2380	12.48	14.0	0.52
GTX 2	160	2252	11.62	24.2	1.43
GTX 3	190	1970	12.52	19.1	5.36
GTX 4	320	3457	20.04	9.5	0.34
GTX 5	320	3834	20.96	16.8	2.19
GTX 6	290	2953	19.62	18.8	8.67

### 3.2 Large scale load test

The large scale laboratory testing was performed in a 12.5 m long and 1.8 m wide test bin filled with a 650 mm thick layer of soft clay with 2.3 kPa undrained shear strength. The geotextiles were placed on the clay and covered with 150 mm of crushed stone as shown in Figure 10. The geotextile samples were 2 x 1.8 m. Cyclic load was then applied on a circular plate with diameter 250 mm on the bearing layer. The geotextiles used in the large scale laboratory test are listed in table 5.

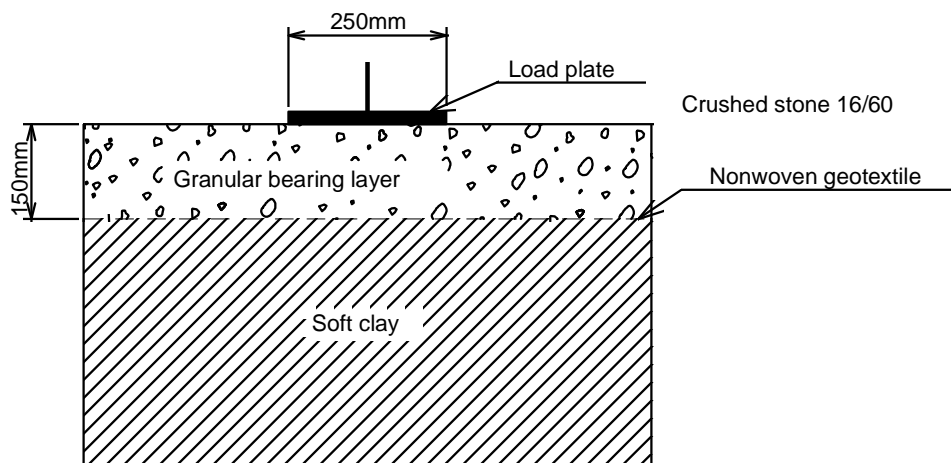

Figure 11. Bearing layer construction

A cyclic load with frequency 1 Hz and amplitude 0-4 kN was applied on the load plate which corresponds to an average applied stress under the load plate of 80 kN/m<sup>2</sup>. The gradually developing displacement on the geotextile beneath the load plate was continuously measured during the test (figure 12). At the end of the test the complete displacement profile after 1000 cycles was estimated (figure 13).

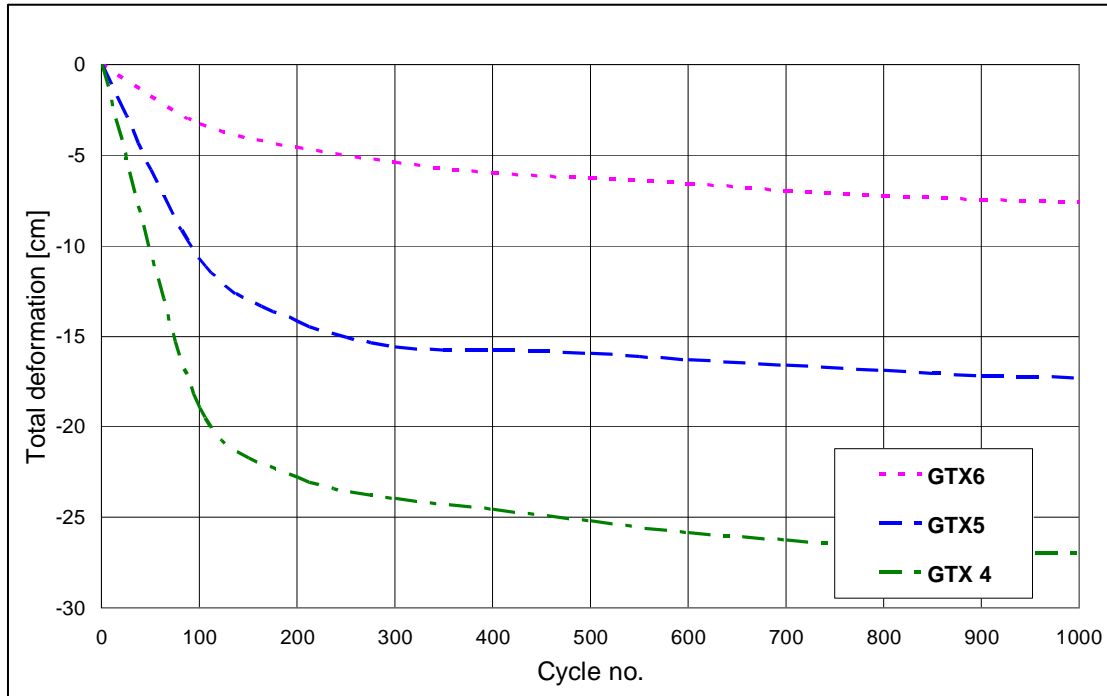

Figure 12. Vertical displacement profile of class 4 geotextiles

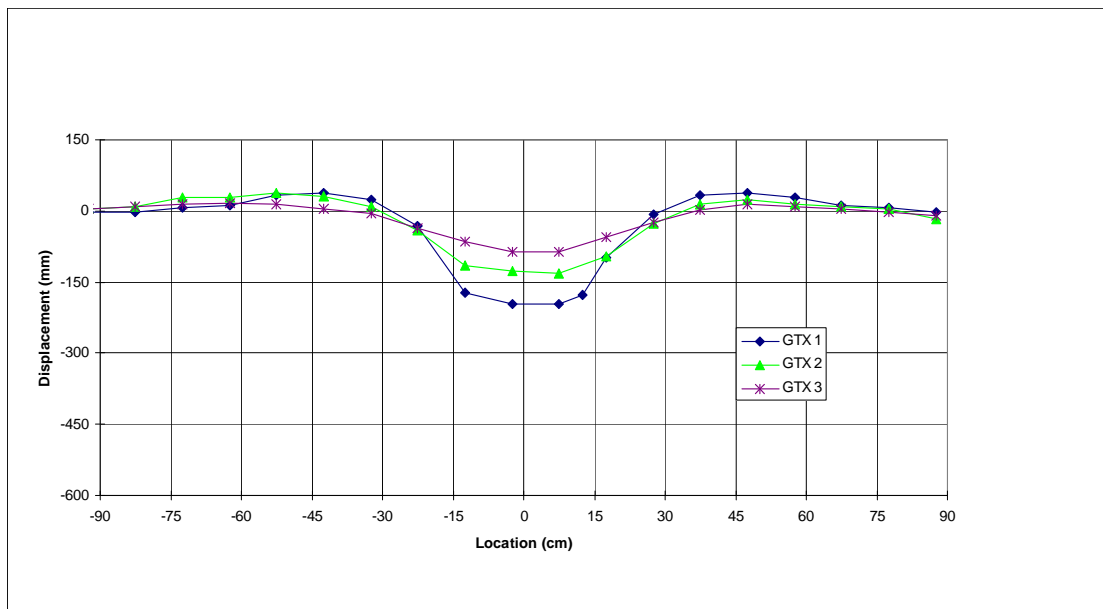

Figure 13. Displacement profile of class 3 geotextiles after 1000 cycles



### 3.3 Evaluation of results

There are considerable differences in the deformation of the structures for each geotextile. The test shows that the strain developing at a typical cyclic loading is strongly dependent of the initial stiffness of the product. The deformation is not correlated with the maximum tensile strength (figure 14). A good correlation however can be found between deformation and strength at 5% of strain (figure 15).

Table 4: Vertical rut depth and Geotextile strength results

Reference	Nominal Weight (g/m <sup>2</sup> )	Tensile Strength EN ISO 10319 kN/m	Strength at 5% EN ISO 10319 kN/m	Vertical Rutting Depth mm
GTX 1	190	12.48	0.52	230
GTX 2	160	11.62	1.43	180
GTX 3	190	12.52	5.36	150
GTX 4	320	20.04	0.34	270
GTX 5	320	20.96	2.19	170
GTX 6	290	19.62	8.67	75

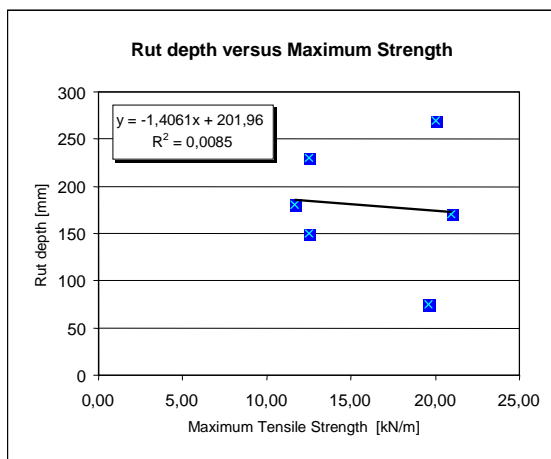

Figure 14: Rut depth versus max. Strength

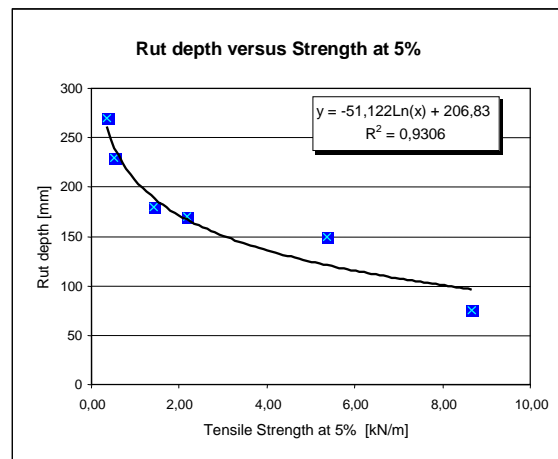

Figure 15: Rut depth versus Strength at 5%

The geotextile strain measured during the test is in good accordance with the calculated average tensile strain based on the deflection curvature. The stress-strain curves differ significantly among the tested geotextiles.

The calculated average geotextile strain for the same load differs from 1.4 % (GTX3) to 10.3 % (GTX1). The strain energy can be defined as the area under the stress strain curve from tensile tests. The strain energy corresponding to the average strain calculated from the large scale tests is indicated for GTX 1 and GTX3 in figure 15.

The strain energy is in the same range even if the strains and the corresponding stresses are different. This indicates that the strain energy can be used for estimating the strain for a given loading independent on the type of geotextile.

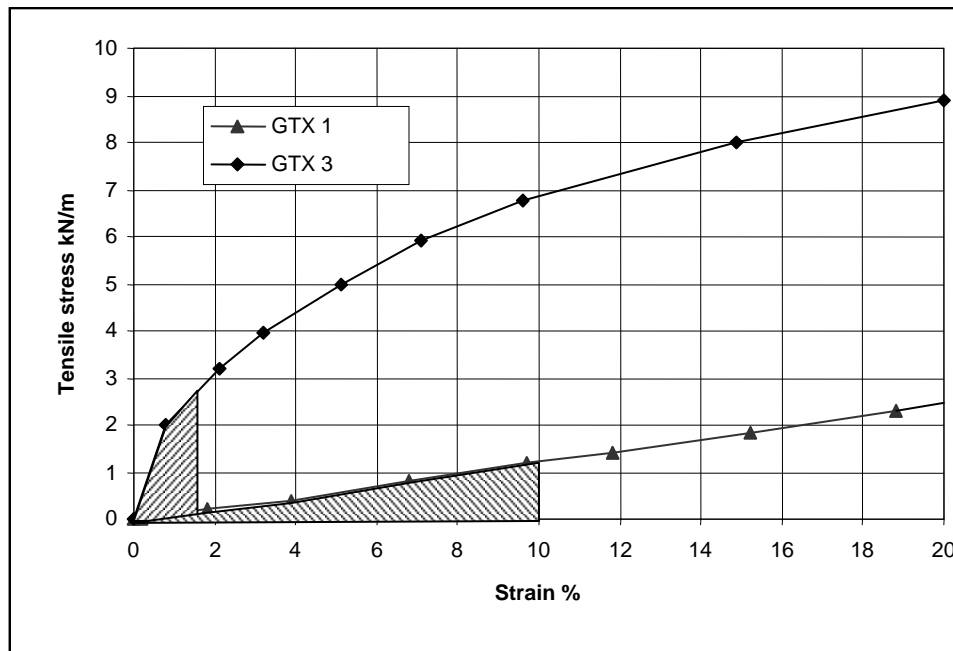

Figure 16. Strain energy for GTX1 and GTX3 corresponding to the average strain found in the large scale tests

#### 4. CONCLUSIONS AND RECOMMENDATIONS

The results showed that a clear correlation between energy absorption and damage resistance has been found for all geotextiles tested, independent of their manufacturing process and physical structure and supports the approach taken by different countries to include the energy absorption into their classification system.

The developed test method allows a rapid and precise damage during installation evaluation of geosynthetics and may be used as a basis for further determining performance related criteria.

A poor correlation has also been found between standard index tests and deformations under load. The deformation of the geotextiles when subjected to loading is clearly linked to the initial stiffness of the geotextile.

There are considerable differences in the stress strain properties of the geotextiles that is also reflected in the behaviour in the field. Noticeable differences are found in the susceptibility for damage during installation. The criteria used in many of the existing systems for classification and specification do not reflect properly the resistance of the products. A revision of the criteria is therefore clearly needed.

#### 5. REFERENCES

- AASHTO (1996): « Standard Specifications for Geotextiles ». American Association of State Highway and Transportation Officials, M288-96, Washington DC
- Diederich R. (2000), Evaluation of installation damage of geotextiles – A correlation to index tests, *Fifth conference on Geosynthetics*, YiChang, China, 24-31
- Nikbakht M., Diederich R. (2006), National European specifications and the energy concept, *Eight International Conference on Geosynthetics*, Yokohama, Japan
- Watn A., Eiksund G., Knutson A. (1998), *Sixth International Conference on Geosynthetics*, Deformations and damage of nonwoven geotextiles in road construction, Atlanta, USA
- EN ISO 10319. Geosynthetics – Wide-width tensile test, CEN, Brussels, Belgium